



Dual Polar Wide Band Horn Antenna 2 to 18 GHz

Catalogue number: **QWH-DL-2-18-S-HG-R**

Q-par reference: **QMS-00447**

Contents: **Summary**
Typical Antenna Gain / Factor
Typical Beamwidth / Patterns
VSWR
Isolation between Connectors

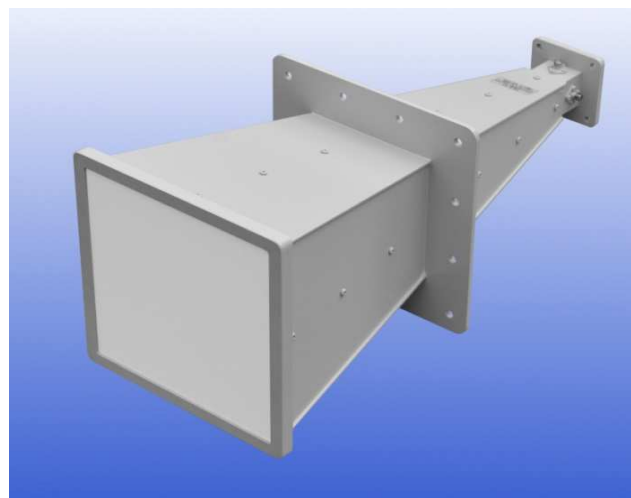

Typical Specification

Frequency	2 to 18 GHz
Connector type	2 x SMA type jack
Power Handling	40 Watt c.w.
VSWR	Typically < 2.5:1
Isolation	> 25 dB (<i>between connectors</i>)
Gain	10 to 21 dBi
Antenna Factor	26 to 37 dB/m
3dB Beamwidth	9 to 55 degrees
10dB Beamwidth	20 to 107 degrees
Weight	2kg nominal
Size- max.	180 mm x 180 mm external aperture x 433 mm long
Mounting	Rear mounting plate with 4 holes, diameter 4 mm, 50 mm centres, plus C of G mount flange with 12 holes, diameter 6 mm, 50 mm centres
Construction	Aluminium and engineering plastics. Painted.

Typical Antenna Gain / Factor

This is calculated by reference to standard gain horn antennas, and cross checked with reference to the antenna beamwidth, with an estimated error of +/- 0.8dB.

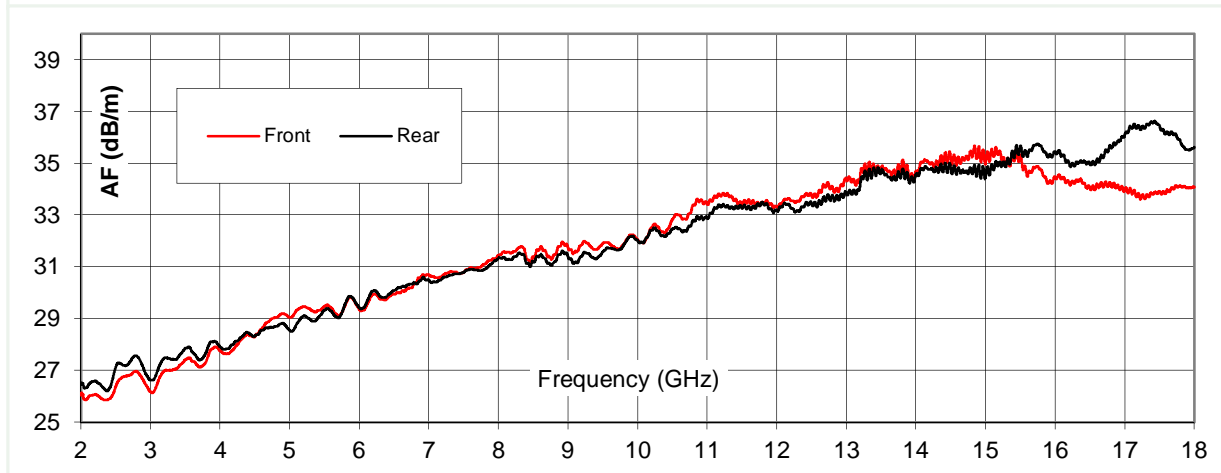
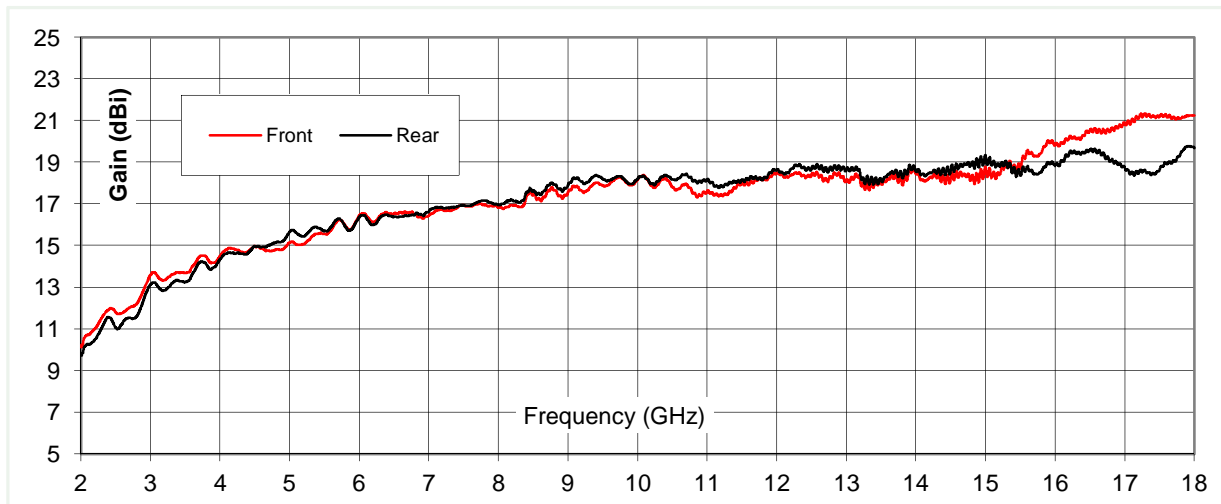

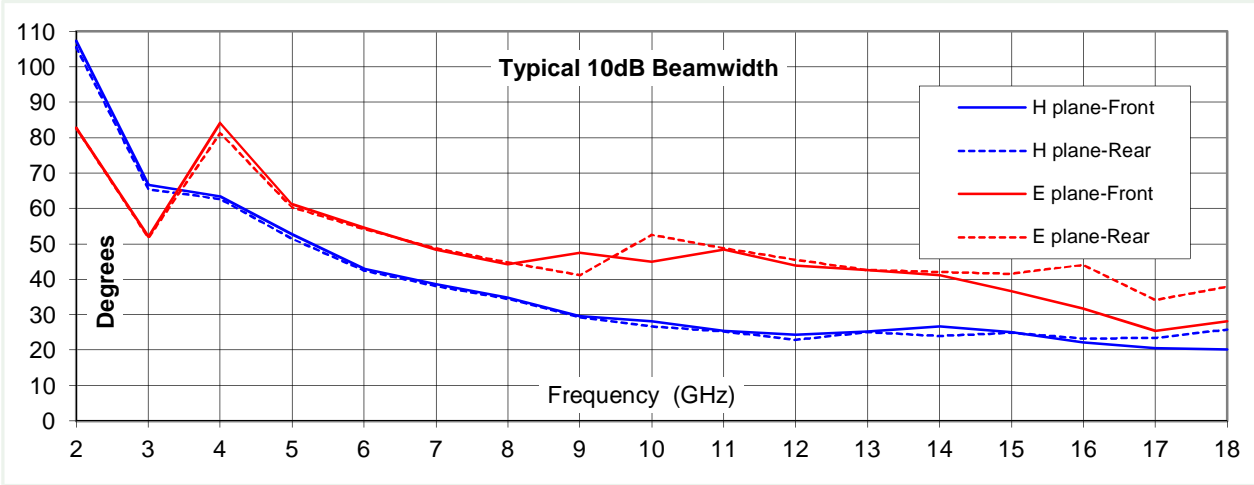
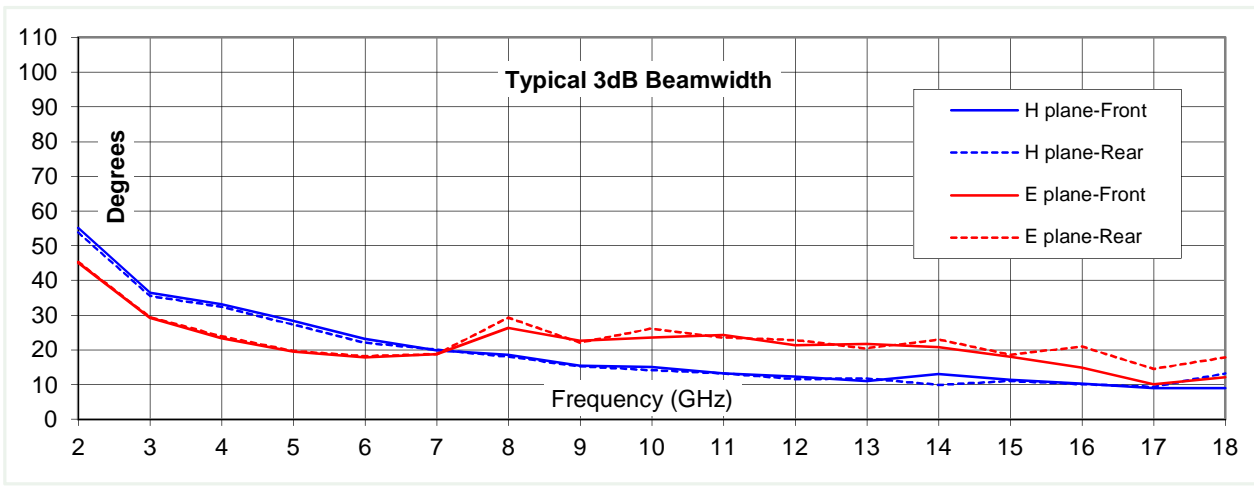

2 GHz

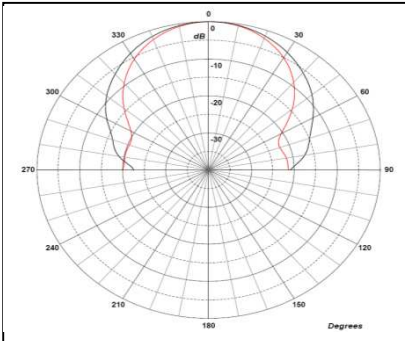

5 GHz

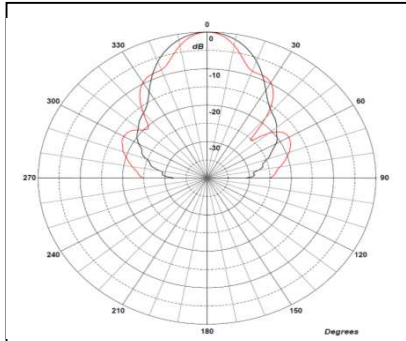

10 GHz

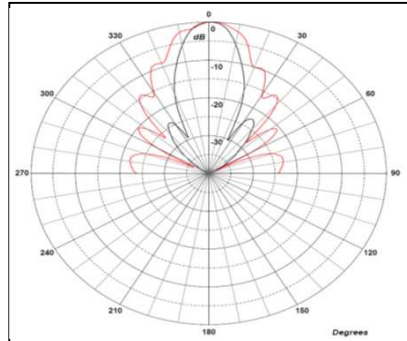

15 GHz

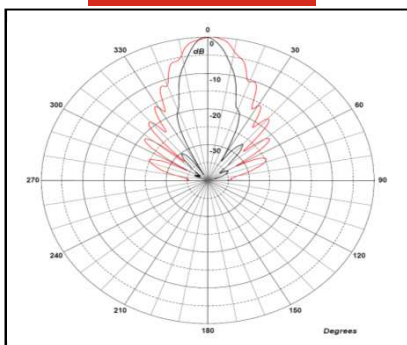

18 GHz

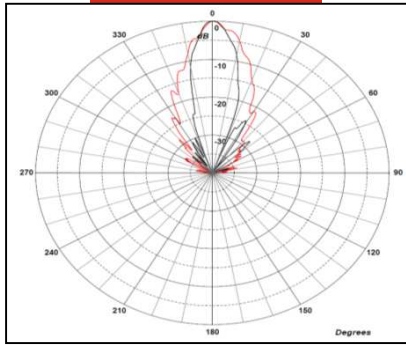

Red trace = E-plane, Black trace = H-plane cut

